

A STUDY OF BEGLIKTASH MEGALITHIC COMPLEX

**Diana Kjurkchieva, Evgeni Stoykov, Sabin Ivanov, Borislav Borisov,
Hristo Hristov, Pencho Kyurkchiev, Dimitar Vladev, Irina Ivanova**
Bishop Konstantin Preslavski University of Shumen

Abstract. The article presents the results of interdisciplinary study of megalithic complex Begliktash conducted by a group of researchers from the University of Shumen. The main conclusion is that Begliktash is a natural phenomenon with interesting stone complex morphology that may have been artificially consolidated and used both to perform rituals and for calendar purposes.

Keywords: Begliktash, megalithic complex, community

Introduction

Two types of megaliths can be found in Bulgaria: menhirs (from men - stone and hir - long) and dolmens (from dol – table, and men – stone). Some groups of menhirs are found near Pliska, whereas the dolmens are predominantly in Southern Bulgaria, mainly in Strandzha and The Rhodopes.

However, there is a third type of megaliths in Bulgaria. They are natural stone complexes with specific morphology, which were most probably shaped by humans and used for ritualistic purposes.

One of these natural phenomena is Begliktash, situated some 5 km away from Primorsko. Karel Skorpil was the first to mention it, writing that near the cape Maslen nos there was a rock which he called Apostle Tash. During the second half of the 20th century the area was not accessible since it was part of a government residence.

The megalith was discovered during archeological excavations led by Drazheva et al. (2003). In 2004 in excavations north of its centre, archeologists found evidence showing that the place had been used as a cult complex with adjacent premises, which makes it the earliest discovered till now Thracian megalithic sanctuary in South-East Thrace and the Black sea coast (from 14th century BC to 4th century AD). All separate megaliths in the complex were given names, corresponding to their supposed purpose. Later, due to its closeness to the sea resorts, the site quickly turned into a tourist attraction. This is probably one of the

reasons why the factual information about the site is accompanied by fictitious elements. The site <http://www.balkanmegaliths.bgjourney.com> gives information only about three dolmens in the area of Begliktash, but not about the whole megalithic complex.

The aim of the article is to present the results of an interdisciplinary study of the megalithic complex Begliktash, which commenced with an expedition of a group of researchers from Shumen University in June 2014.

Our measurements at Begliktash

An overview of the site shows that it is located at the highest point of an area stretching along the crest of Maslen nos, with an altitude of approximately 200 m. Unlike the surrounding area covered with trees and bushes, the megalithic complex lies on naturally polished granite rocks. The megaliths themselves are huge (sizes between 2 and 10 m) and have distinctly rounded shapes.



Fig. 1. Google satellite map of the area

The satellite picture (Fig.1) shows that the complex is located in the Northern part of a big meadow with an almost round shape. From a close range one cannot see clearly the outlines of the huge separate megaliths (probably due to the reflection from their glossy surface).

Geodetic measurements

Geodetic measurements were carried out with a dual band GPS receiver Trimble R4-3 in Real Time Kinematic (PTK) mode by using the permanent GPS network GeoNet. The receiver provides accuracy location of ± 2 cm. The measurements are made at every point within 40 – 60 sec.

They are made at 266 points in total, and their coordinates (latitude j , longitude l and altitude h) are given in Table 1.

Table 1. The object – coordinates

Nº	Latitude	Longitude	Attitude
1	N42°18'41.28774"	E27°46'00.84333"	165.251
2	N42°18'41.30704"	E27°46'00.88810"	165.309
3	N42°18'41.33419"	E27°46'00.80156"	165.075
4	N42°18'41.27994"	E27°46'00.75750"	165.081
5	N42°18'41.26223"	E27°46'00.69794"	164.896
6	N42°18'41.36173"	E27°46'00.65280"	164.828
7	N42°18'41.49802"	E27°46'00.68911"	164.665
8	N42°18'41.56452"	E27°46'00.61961"	164.461
9	N42°18'41.73506"	E27°46'00.76608"	165.053
10	N42°18'41.81152"	E27°46'00.85095"	165.555
11	N42°18'41.78267"	E27°46'00.99315"	166.422
12	N42°18'41.61070"	E27°46'00.98382"	165.659
13	N42°18'41.54533"	E27°46'01.07326"	165.538
14	N42°18'41.33852"	E27°46'00.95583"	165.240
15	N42°18'41.33738"	E27°46'00.92544"	165.325
16	N42°18'41.75139"	E27°46'01.03468"	166.055
17	N42°18'41.72707"	E27°46'01.07072"	165.926
18	N42°18'41.70093"	E27°46'01.15582"	165.884
19	N42°18'41.71056"	E27°46'01.29445"	165.914
20	N42°18'41.73786"	E27°46'01.31529"	165.941
21	N42°18'41.80836"	E27°46'01.15898"	166.108
22	N42°18'41.81631"	E27°46'01.10950"	166.230
23	N42°18'41.85592"	E27°46'01.10653"	165.969
24	N42°18'41.87893"	E27°46'01.05685"	165.778
25	N42°18'41.93850"	E27°46'01.08945"	165.788
26	N42°18'41.87888"	E27°46'01.18808"	165.946
27	N42°18'41.81849"	E27°46'01.18009"	166.168
28	N42°18'41.79760"	E27°46'01.35502"	166.033
29	N42°18'41.85260"	E27°46'01.34464"	166.037
30	N42°18'41.90101"	E27°46'01.32830"	165.957
31	N42°18'41.96210"	E27°46'01.31885"	165.953
32	N42°18'41.98628"	E27°46'01.21729"	165.744
33	N42°18'42.09548"	E27°46'01.54009"	166.384
34	N42°18'42.03008"	E27°46'01.44622"	165.850

Nº	Latitude	Longitude	Attitude
35	N42°18'41.93555"	E27°46'01.37636"	165.710
36	N42°18'41.90826"	E27°46'01.44411"	165.945
37	N42°18'41.90536"	E27°46'01.49801"	165.888
38	N42°18'41.90337"	E27°46'01.55066"	166.030
39	N42°18'41.76305"	E27°46'01.59688"	165.965
40	N42°18'41.74101"	E27°46'01.66371"	166.155
41	N42°18'41.77622"	E27°46'01.79030"	166.224
42	N42°18'41.81698"	E27°46'01.81968"	166.366
43	N42°18'41.92838"	E27°46'01.77651"	166.423
44	N42°18'41.89063"	E27°46'01.82116"	166.364
45	N42°18'41.85092"	E27°46'01.86867"	166.342
46	N42°18'41.87200"	E27°46'01.91180"	166.447
47	N42°18'41.90746"	E27°46'01.87524"	166.273
48	N42°18'41.95577"	E27°46'01.83894"	166.363
49	N42°18'41.95557"	E27°46'01.76556"	166.548
50	N42°18'42.03100"	E27°46'01.81288"	166.849
51	N42°18'42.02794"	E27°46'01.74989"	167.052
52	N42°18'42.00477"	E27°46'01.71510"	166.998
53	N42°18'41.97803"	E27°46'01.63301"	166.894
54	N42°18'42.09954"	E27°46'01.60183"	167.344
55	N42°18'42.18481"	E27°46'01.48285"	166.182
56	N42°18'42.18128"	E27°46'01.38809"	165.925
57	N42°18'42.26082"	E27°46'01.44031"	166.296
58	N42°18'42.09574"	E27°46'01.83725"	166.923
59	N42°18'42.02500"	E27°46'01.84168"	167.005
60	N42°18'41.81644"	E27°46'01.98998"	166.428
61	N42°18'41.82242"	E27°46'02.18613"	166.499
62	N42°18'41.79207"	E27°46'02.18322"	166.854
63	N42°18'41.76309"	E27°46'02.21723"	167.009
64	N42°18'41.81590"	E27°46'02.27022"	166.978
65	N42°18'41.75502"	E27°46'02.26619"	166.909
66	N42°18'41.74731"	E27°46'02.30174"	167.043
67	N42°18'41.74820"	E27°46'02.27405"	166.652
68	N42°18'41.61332"	E27°46'02.06824"	166.371
69	N42°18'41.77715"	E27°46'02.34352"	167.350

Nº	Latitude	Longitude	Attitude
70	N42°18'41.75070"	E27°46'02.35164"	167.023
71	N42°18'41.73417"	E27°46'02.40009"	167.003
72	N42°18'41.75263"	E27°46'02.47749"	167.027
73	N42°18'41.81726"	E27°46'02.57393"	167.294
74	N42°18'41.84547"	E27°46'02.43627"	167.342
75	N42°18'41.84249"	E27°46'02.32713"	167.431
76	N42°18'41.95926"	E27°46'02.19643"	167.562
77	N42°18'42.04628"	E27°46'02.17680"	167.889
78	N42°18'42.09726"	E27°46'02.18354"	167.737
79	N42°18'42.19860"	E27°46'02.15188"	167.411
80	N42°18'42.22651"	E27°46'02.05827"	167.192
81	N42°18'41.48134"	E27°46'02.49949"	166.264
82	N42°18'41.42481"	E27°46'02.34543"	166.015
83	N42°18'41.41453"	E27°46'02.31272"	165.829
84	N42°18'41.47343"	E27°46'02.24740"	166.213
85	N42°18'41.40696"	E27°46'02.23484"	165.531
86	N42°18'41.24784"	E27°46'02.36141"	164.314
87	N42°18'41.40386"	E27°46'02.05116"	165.729
88	N42°18'41.41135"	E27°46'02.00666"	165.714
89	N42°18'41.43452"	E27°46'02.02521"	165.999
90	N42°18'41.42915"	E27°46'02.05058"	165.764
91	N42°18'41.25648"	E27°46'01.98635"	165.261
92	N42°18'41.24022"	E27°46'01.99152"	165.191
93	N42°18'41.22891"	E27°46'01.95736"	165.139
94	N42°18'41.24548"	E27°46'01.94276"	165.208
95	N42°18'41.21075"	E27°46'02.01487"	165.342
96	N42°18'41.23672"	E27°46'01.88157"	165.138
97	N42°18'41.21986"	E27°46'01.86028"	164.892
98	N42°18'41.23798"	E27°46'01.84375"	165.106
99	N42°18'41.21127"	E27°46'01.82395"	164.789
100	N42°18'41.30991"	E27°46'01.83366"	165.851
101	N42°18'41.41220"	E27°46'01.82359"	166.179
102	N42°18'41.50089"	E27°46'01.75708"	166.243
103	N42°18'41.47153"	E27°46'01.64283"	166.206
104	N42°18'41.49703"	E27°46'01.58103"	165.752

№	Latitude	Longitude	Attitude
105	N42°18'41.42383"	E27°46'01.52547"	166.349
106	N42°18'41.40977"	E27°46'01.46430"	166.181
107	N42°18'41.36537"	E27°46'01.43166"	165.939
108	N42°18'41.34950"	E27°46'01.38039"	165.624
109	N42°18'41.26035"	E27°46'01.43456"	165.665
110	N42°18'41.23802"	E27°46'01.49558"	165.630
111	N42°18'41.23252"	E27°46'01.61448"	165.589
112	N42°18'41.19796"	E27°46'01.71678"	165.242
113	N42°18'41.62401"	E27°46'02.67072"	166.690
114	N42°18'41.58623"	E27°46'02.63976"	166.444
115	N42°18'41.58680"	E27°46'02.62558"	166.420
116	N42°18'41.53007"	E27°46'02.62509"	166.191
117	N42°18'41.50195"	E27°46'02.64600"	166.194
118	N42°18'41.43772"	E27°46'02.63796"	166.220
119	N42°18'41.38925"	E27°46'02.70319"	165.509
120	N42°18'41.38266"	E27°46'02.76315"	165.194
121	N42°18'41.40733"	E27°46'02.85372"	164.315
122	N42°18'41.46740"	E27°46'02.73652"	166.455
123	N42°18'41.46221"	E27°46'02.81261"	165.995
124	N42°18'41.45950"	E27°46'02.85902"	165.395
125	N42°18'41.52105"	E27°46'02.89096"	165.775
126	N42°18'41.52432"	E27°46'02.87913"	165.863
127	N42°18'41.56513"	E27°46'02.90305"	166.590
128	N42°18'41.61239"	E27°46'02.88341"	166.715
129	N42°18'41.62502"	E27°46'02.79219"	166.787
130	N42°18'41.60905"	E27°46'02.76569"	166.707
131	N42°18'41.56064"	E27°46'02.74181"	166.604
132	N42°18'41.59884"	E27°46'02.95213"	166.069
133	N42°18'41.89941"	E27°46'02.89983"	167.267
134	N42°18'41.89580"	E27°46'02.93340"	167.612
135	N42°18'41.96718"	E27°46'03.01558"	167.079
136	N42°18'41.90499"	E27°46'03.07262"	168.137
137	N42°18'41.89274"	E27°46'03.16468"	167.371
138	N42°18'41.66279"	E27°46'03.07380"	168.056
139	N42°18'41.66709"	E27°46'03.10894"	167.932

Nº	Latitude	Longitude	Attitude
140	N42°18'41.72000"	E27°46'03.15715"	167.705
141	N42°18'41.89286"	E27°46'03.17048"	167.375
142	N42°18'41.93496"	E27°46'03.31518"	167.669
143	N42°18'41.87398"	E27°46'03.41541"	167.268
144	N42°18'41.81231"	E27°46'03.44445"	165.821
145	N42°18'41.80724"	E27°46'03.44759"	166.036
146	N42°18'41.80874"	E27°46'03.49526"	165.703
147	N42°18'41.59414"	E27°46'03.58724"	168.989
148	N42°18'41.55494"	E27°46'03.37954"	164.172
149	N42°18'41.60449"	E27°46'03.37186"	164.121
150	N42°18'41.62674"	E27°46'03.29815"	164.326
151	N42°18'41.59322"	E27°46'03.29339"	164.479
152	N42°18'41.58513"	E27°46'03.20483"	164.294
153	N42°18'41.56246"	E27°46'03.21171"	159.431
154	N42°18'41.49573"	E27°46'03.08526"	168.878
155	N42°18'42.09106"	E27°46'03.14517"	167.428
156	N42°18'42.03806"	E27°46'03.03275"	167.742
157	N42°18'42.00373"	E27°46'02.89144"	167.706
158	N42°18'41.93002"	E27°46'02.59549"	167.147
159	N42°18'42.02103"	E27°46'02.54720"	167.174
160	N42°18'42.12041"	E27°46'02.56134"	167.634
161	N42°18'42.14181"	E27°46'02.66624"	167.876
162	N42°18'42.18952"	E27°46'02.69842"	168.179
163	N42°18'42.21581"	E27°46'02.77335"	168.125
164	N42°18'42.16499"	E27°46'02.82163"	168.045
165	N42°18'42.21802"	E27°46'03.11124"	167.721
166	N42°18'42.20293"	E27°46'03.17208"	167.655
167	N42°18'42.30791"	E27°46'03.46906"	167.522
168	N42°18'42.57748"	E27°46'03.42123"	167.614
169	N42°18'42.84724"	E27°46'03.75597"	166.760
170	N42°18'42.82777"	E27°46'03.95904"	166.456
171	N42°18'42.67351"	E27°46'04.12573"	166.077
172	N42°18'42.51579"	E27°46'04.31152"	167.058
173	N42°18'42.34118"	E27°46'04.19448"	164.551
174	N42°18'42.29121"	E27°46'04.11749"	164.523

№	Latitude	Longitude	Attitude
175	N42°18'42.28708"	E27°46'04.12094"	164.437
176	N42°18'42.25912"	E27°46'03.92257"	165.208
177	N42°18'42.18364"	E27°46'03.62548"	166.670
178	N42°18'42.33299"	E27°46'03.54664"	167.429
179	N42°18'42.62465"	E27°46'03.47348"	167.626
180	N42°18'42.65067"	E27°46'03.92452"	166.533
181	N42°18'42.63019"	E27°46'03.96074"	166.364
182	N42°18'42.28226"	E27°46'04.08748"	164.462
183	N42°18'42.19828"	E27°46'04.13060"	164.217
184	N42°18'43.45583"	E27°46'04.55706"	164.449
185	N42°18'43.51205"	E27°46'04.52849"	164.744
186	N42°18'43.48734"	E27°46'04.61818"	164.318
187	N42°18'43.47799"	E27°46'04.66841"	164.308
188	N42°18'43.47839"	E27°46'04.71962"	164.119
189	N42°18'43.50139"	E27°46'04.74255"	164.095
190	N42°18'43.48327"	E27°46'04.80549"	163.950
191	N42°18'43.59442"	E27°46'04.84382"	163.899
192	N42°18'43.67305"	E27°46'04.86260"	163.804
193	N42°18'43.73128"	E27°46'04.77801"	164.080
194	N42°18'43.67921"	E27°46'04.67306"	164.660
195	N42°18'43.61084"	E27°46'04.65405"	164.959
196	N42°18'43.56564"	E27°46'04.66042"	164.708
197	N42°18'43.75001"	E27°46'04.80255"	164.072
198	N42°18'43.73889"	E27°46'04.74413"	164.199
199	N42°18'43.75208"	E27°46'04.69226"	164.198
200	N42°18'43.83951"	E27°46'04.67714"	165.631
201	N42°18'43.90655"	E27°46'04.66648"	165.847
202	N42°18'43.95741"	E27°46'04.66428"	165.760
203	N42°18'43.98181"	E27°46'04.69420"	165.608
204	N42°18'43.98726"	E27°46'04.72198"	165.560
205	N42°18'43.96997"	E27°46'04.75639"	165.316
206	N42°18'43.91789"	E27°46'04.73352"	164.953
207	N42°18'43.82042"	E27°46'04.77965"	165.139
208	N42°18'43.73297"	E27°46'04.84597"	163.504
209	N42°18'43.75999"	E27°46'04.91825"	163.453

Nº	Latitude	Longitude	Attitude
210	N42°18'43.76732"	E27°46'04.99233"	163.121
211	N42°18'44.01251"	E27°46'04.97486"	163.112
212	N42°18'44.04234"	E27°46'04.92104"	163.054
213	N42°18'44.04478"	E27°46'04.86763"	163.012
214	N42°18'44.01880"	E27°46'04.82719"	163.083
215	N42°18'44.08442"	E27°46'05.76178"	163.711
216	N42°18'44.06293"	E27°46'05.78936"	163.648
217	N42°18'44.04814"	E27°46'05.81668"	163.505
218	N42°18'44.02143"	E27°46'05.80525"	163.439
219	N42°18'44.02149"	E27°46'05.77315"	163.489
220	N42°18'44.04810"	E27°46'05.74876"	163.702
221	N42°18'44.13720"	E27°46'05.85559"	163.330
222	N42°18'44.10711"	E27°46'05.85770"	163.316
223	N42°18'44.08901"	E27°46'05.89264"	162.888
224	N42°18'44.11479"	E27°46'05.90477"	163.335
225	N42°18'44.13986"	E27°46'05.89753"	162.881
226	N42°18'44.18521"	E27°46'05.91279"	162.746
227	N42°18'44.13615"	E27°46'05.95717"	162.655
228	N42°18'44.09157"	E27°46'05.95107"	162.692
229	N42°18'44.09216"	E27°46'05.91861"	162.751
230	N42°18'44.87212"	E27°46'06.71884"	160.692
231	N42°18'44.78761"	E27°46'06.71075"	161.077
232	N42°18'44.80355"	E27°46'06.81221"	161.072
233	N42°18'42.41889"	E27°46'02.99803"	167.911
234	N42°18'42.49254"	E27°46'02.96072"	167.749
235	N42°18'42.53042"	E27°46'03.00078"	167.749
236	N42°18'42.54024"	E27°46'03.05263"	167.822
237	N42°18'42.50628"	E27°46'03.09343"	168.025
238	N42°18'42.44994"	E27°46'03.08222"	167.993
257	N42°18'32.81369"	E27°45'01.62307"	171.614
258	N42°18'32.82430"	E27°45'01.61752"	171.616
259	N42°18'32.83187"	E27°45'01.61349"	171.148
260	N42°18'32.89789"	E27°45'01.67438"	171.971
261	N42°18'32.89106"	E27°45'01.65047"	171.770
262	N42°18'32.90002"	E27°45'01.60183"	171.787

Nº	Latitude	Longitude	Attitude
263	N42°18'32.92053"	E27°45'01.58999"	171.906
265	N42°18'32.82588"	E27°45'01.55233"	171.719
266	N42°18'32.83868"	E27°45'01.56586"	171.512

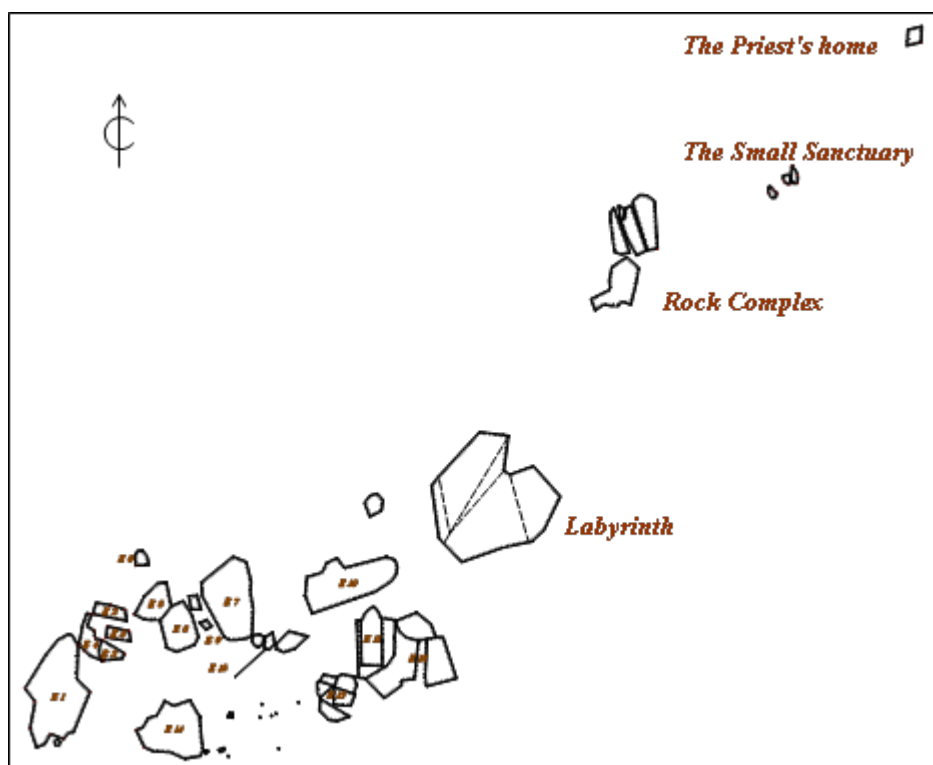

Fig. 2. Our geodetic map of the area with the arrow pointing at geographic North

The complete geodetic map (Fig.2) shows that the main megaliths are situated along the periphery of an oblate ellipse, the long axis of which is oriented almost precisely in East-West direction (Fig.3). The axes of the ellipse are 60 m and 30 m long respectively.

For each of the megaliths at least 3 point were measured which were considered sufficient to define its shape and size (Fig.3).

In this way the megaliths enclose an almost flat central space completely covered with smooth granite rocks. To the south of the complex is the meadow (Fig.1), whose level is 2 – 3 meters lower than the megaliths. This configuration forms a

natural stage for performing rituals which can be watched by a big audience from the lawn (Fig.4).

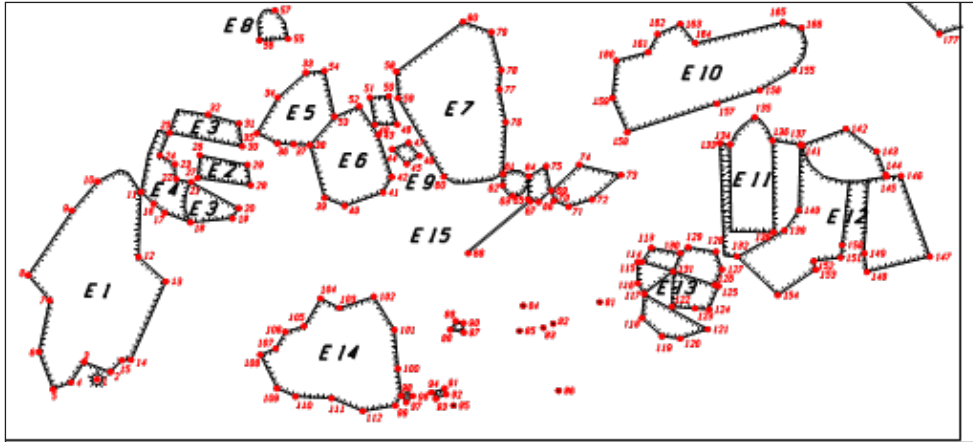

Fig. 3. The main part of Begliktash complex; geographic North at the top



Fig. 4. On 24th June 2014 (day of Enyo, around solstice) at 5 am at Begliktash we attended a re-enactment of a Thracian ritual (view from the Menhir)

Geological evaluation of the complex

The Thracian megalithic sanctuary Begliktash, situated at about 2200 m from cape Maslen nos in West-North-West direction and 800 m from mount Kitka in North-East, is a group of megalithic syenite rocks of different shape and size, which are part of Rosen palaeovolcano (Fig.5). The megaliths stand on a sub-horizontal rocky platform which is sinking due to the fissures in the rocks. The orientation of the walls of the rock blocks on the surface (including the majority of rock blocks in the area of the sanctuary) corresponds to the sub-vertical fissures seen at the base of the rocks facing East-West and North-South. The coincidence of the direction of rock fissures with the development of megaliths' walls is a certain proof that the megaliths in the area had formed in situ as a result of spherical weathering following the original fissures in the syenite rocks. Presumably later, as a result of an earthquake or a series of earthquakes, some of the rock blocks leaned to one side, whereas separate blocks were even slightly displaced at their base. The ancient inhabitants of this part of the Black sea coast must have appreciated the grandeur and the specific orientation of the rock blocks and made them a place of worship.

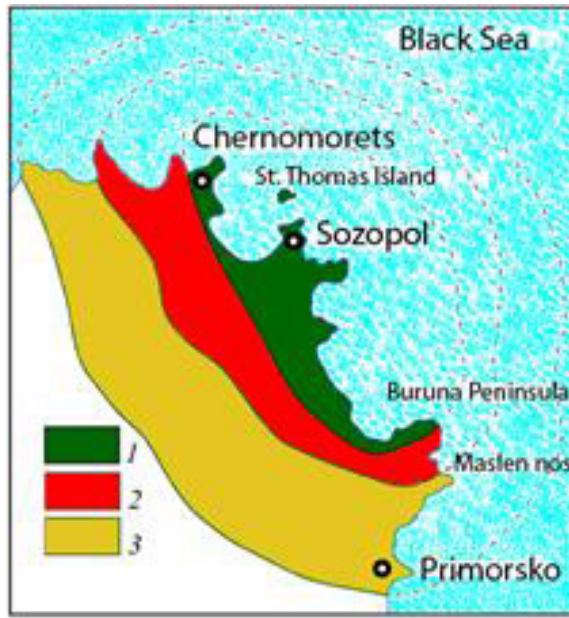

Fig. 5. A scheme of the structure of Rosen palaeovolcano
1 – remains of the caldera of the volcano; 2 – remains of the ring fracture
intrusion; 3 – remains of the soma

Physical measurements

The magnetic field of the Earth and radioactivity were measured at 10 points in the area and 2 control points located at 100 m and 5 km away from the site.

Radioactivity was measured with a dosimeter PM 1402.

The magnetic field was measured with a sensor DT156, based on the Hall effect. The sensor is connected to a computer through a Data Logger. Special software visualizes the data from the magnetic field in a direction parallel with the sensor. We measured the horizontal H and the vertical Z components of induction of the Earth magnetic field $F = \sqrt{H^2 + Z^2}$. We used a compass to align the sensor with the horizontal component, and a plumb to align it vertically.

The data from our measurements are given in Table 2.

Table 2. Physical measurements

Point	Doze rate $\mu\text{Sv/h}$	Earth magnetic field		
		H (mT)	Z (mT)	F (mT)
1	0,24	0,072	0,092	0,1168
2	0,27	0,064	0,091	0,1113
3	0,30	0,061	0,091	0,1096
4	0,26	0,072	0,091	0,1160
5	0,34	0,061	0,093	0,1112
6	0,27	0,075	0,091	0,1179
7	0,31	0,073	0,092	0,1174
8	0,30	0,075	0,092	0,1187
9	0,21	0,074	0,093	0,1188
10	0,27	0,065	0,093	0,1135
CP – at 100 m	0,16	0,057	0,078	0,0966
CP – at 5 km	0,18	0,057	0,072	0,0918

Their analysis resulted in the following conclusions: (1) The doze rate at all points in the area is higher than at control points (CP), with its maximum values reaching twice the normal rate; (2) At all points in the area the value of magnetic strength is higher than the value at the control points by 1.5 times.

The anomalies in the radioactivity and magnetic field in the area are connected with the rocks the complex lies on. It is possible that these anomalies lead to specific physical feelings of some people which might be the reason why in prehistoric times the site was chosen for performing rituals. Another possible reason is that the site is located at the highest point in the area and provides a good view of the sea below (Fig.6).

By measuring the size of the megaliths and their average density we came to the conclusion that their maximum total mass amounts to hundreds of tons. This means that it would have been impossible to transport them to the site by means of primitive mechanical devices. This in turns leads to the logical assumption that the megaliths are a natural phenomenon, a fact which is confirmed by their rounded shapes.

Most of the colossal stones are dug into the ground, but a few look as if they were moved to the site by rolling, as their bottom is visible on the rocks underneath. This seems strange because there are no rock formations in the vicinity from which these stones could have been split.



Fig. 6. A view from the highest point of the complex facing North

As the megaliths at Begliktash are of hard syenite, their knapping is quite difficult. Therefore, it is not surprising that they reveal very few traces of manual treatment.

Morphological description of monoliths

The megaliths of the complex are colossal. On quite a few of them there are vertical crevices resulting from natural processes. It could be assumed that in prehistoric times they formed a whole massive structure, which gradually split into parts.

Element 1. (Entrance). It is an oval stone area in the West end of the complex, paved with large polished syenite slabs (Fig.7). Its dimensions are about 12 x 8.5 m, and its long axis makes an angle of 30° with the North-South direction (Fig.3). Its central part is 3 m wide and 12 m long, and is separated from its periphery by crevices which are about 30 cm wide.

Element 2. (Matrimonial bed). It has a shape very close to a parallelepiped (Fig.8) which is 4,8 m long, 60 cm high and 2 m wide. Its long axis is almost precisely oriented in the East - West direction (Fig.3). It seems possible for the flat upper surface of Element 2 to have been manually knapped, however it might be the case that it had simply split from the megalith on its right, whose vertical wall is almost flat.

Element 3. (Sacrificial altar). It consists of two megaliths which are about 3 m tall, located almost perpendicularly on either side of Element 2 (Fig. 9). The one on the left is thinner at its East end and is 4 m long, whereas the right one is shaped like a parallelepiped and is 5.2 m long.



Fig. 7. The entrance



Fig. 8. Matrimonial bed

Element 4. To the West of element 3 there are two adjoining megaliths (Fig. 9 at the background). One of them is shaped like a cube with a size of 2 m., and the other – like a parallelepiped, whose dimensions are 2 x 2 x 5 m.



Fig. 9. The altars and the matrimonial bed are in the background



Fig. 10. Element 5

Elements 5-6-7. To the East of elements 2 – 4 are situated 3 huge and quite rounded stones (in Fig.9 two of them – 5 and 6, can be seen in the foreground). The adjoining elements 5-6 are more than 4 m tall.

At one end of the upper surface of element 5 (Fig. 10) there is a man-made crevice which is 30 cm deep and 80 cm long, and at the opposite end – a seating place, or perhaps a hand-carved bathtub overlooking East.



Fig. 11. Element 6



Fig. 12. Element 7

Element 6 has the shape of a parallelepiped with an even flat surface (Fig. 11).

Almost parallel with Element 6, located to the East of it, is the biggest in its transverse dimension and height element 7, called the Menhir (Fig.12). Its long side is points from North to South, and its top surface is quite steep. On it there is an indentation which is 60 cm long, 34 cm wide and 2 cm deep and is shaped like a step, which is why it is called „The step of God”.



Fig. 13. Element 8

Element 8. To the North-West of the group 5-6-7 there is a low stone, element 8, which has man-made gutter (Fig.13).



Fig. 14. The Throne

Element 9. (The Throne). It is situated between the Menhir and Element 6. It is a piece of rock measuring 1.90 m x 1.60 m x 1 m, on which there is a man-carved seat whose dimensions are 70 cm x 80 cm x 30 cm (Fig. 14). A man sitting on it would face South.

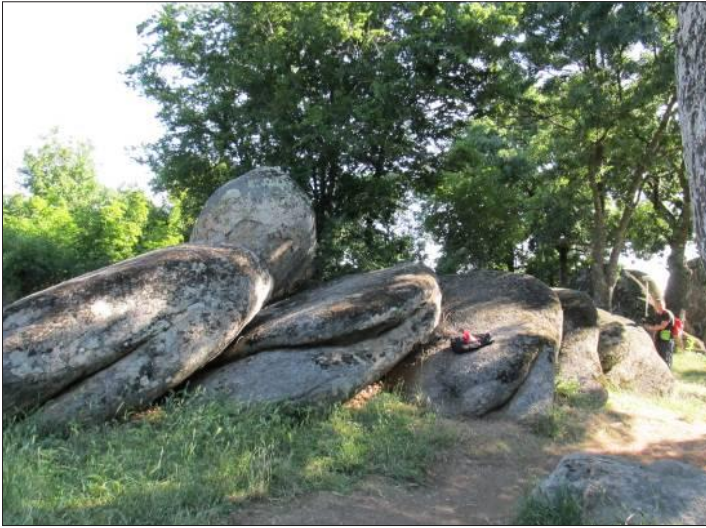

Fig. 15. The slabs of „The Sundial”

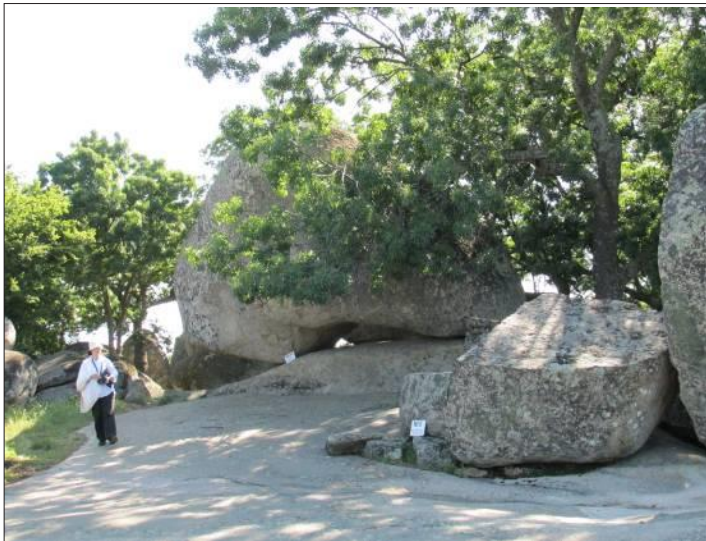

Fig. 16. Apostle Tash, viewed from North

Element 10. (The Sundial). It is a group of 6 stone slabs lying in close proximity on the ground. They have the size of 6 m x 2.5 m and are 60 – 80 cm thick (Fig.15). By all probability they once stood upright, but now they are lying at an angle of 30 degrees towards the horizon. Tourist guides tell visitors that there were 16 slabs, arranged in a circle which was used as a sundial. From the present location and number of plates it is difficult to prove this hypothesis.

Element 11. (Apostle Tash). It is a colossal vertical slab, 2 m thick, oriented towards North-South (Fig. 3). It is shaped like a heart which is 8 m long and 6.5 m tall (Fig.16). This megalith is not dug into the ground, but lies on the surface on two points (lines) of support, between which there is a 50-cm-high niche strictly pointing East. When this huge slab is viewed from the West on its slanting surface are visible 2 parallel gutters (Fig.17). The version, according to which the shadow, thrown by Apostle Tash slab in sunny weather on the lying to the North smaller slabs, represents a sundial does not seem plausible, because for sundials people usually use stick-like objects rather than huge slabs, like Apostle Tash.

Element 12. (The Holy Cave). This easternmost part of the complex is a natural dolmen. It is consisted of two vertical stone props, which are 1.5 m wide and 2 m high, on which lies a huge lid-like stone with a flat upper surface and a bulging lower part which is 1 m thick in the middle (Fig.18). They enclose a two-meter-wide cavity whose long axis is 9 m and is oriented from North to South (Fig.3). A comparison between the shape of the lid and the eastern wall of Element 11 shows that the covering plate of the Holy Cave might have been split (either naturally or artificially) from Apostle Tash.

Element 13. These are megalith fragments (Figs.19-20) located in South-West direction from Element 11. The megalith was destroyed in 1980s (for stone to be used for making cobblestones).

Element 14. Several low rounded stones in the southernmost part of the platform measuring 2-3 m complete the stone stage of Begliktash (Fig.3). On one of them could be seen the second „Step of God” (Fig.21).

Element 15. (The Stone Platform). The inner space enclosed by megaliths 1 – 14 is covered by large rounded stone formations. They are crossed by a system of parallel gutters and round indentations (10 baths in total), the largest two of which have a diameter of 65 cm and a depth of 20 cm (Fig.22). The deepest gutter is visible on fig.3 as a straight line leading to centre of the platform.

On the platform there are two long stones shaped like a frustum with a height of 1.7 m and a base of 0.7 m. It is not known whether this was their original position or they were placed there later to prove the legends told to visitors.

In the southern part of the platform there are 10 holes (points 81 – 86 on Fig. 3), the largest of which has a diameter of 20 cm and a depth of 40 cm (Fig.22). Their configuration is not shaped like a constellation, contrary to what tour guides say (Fig.3).

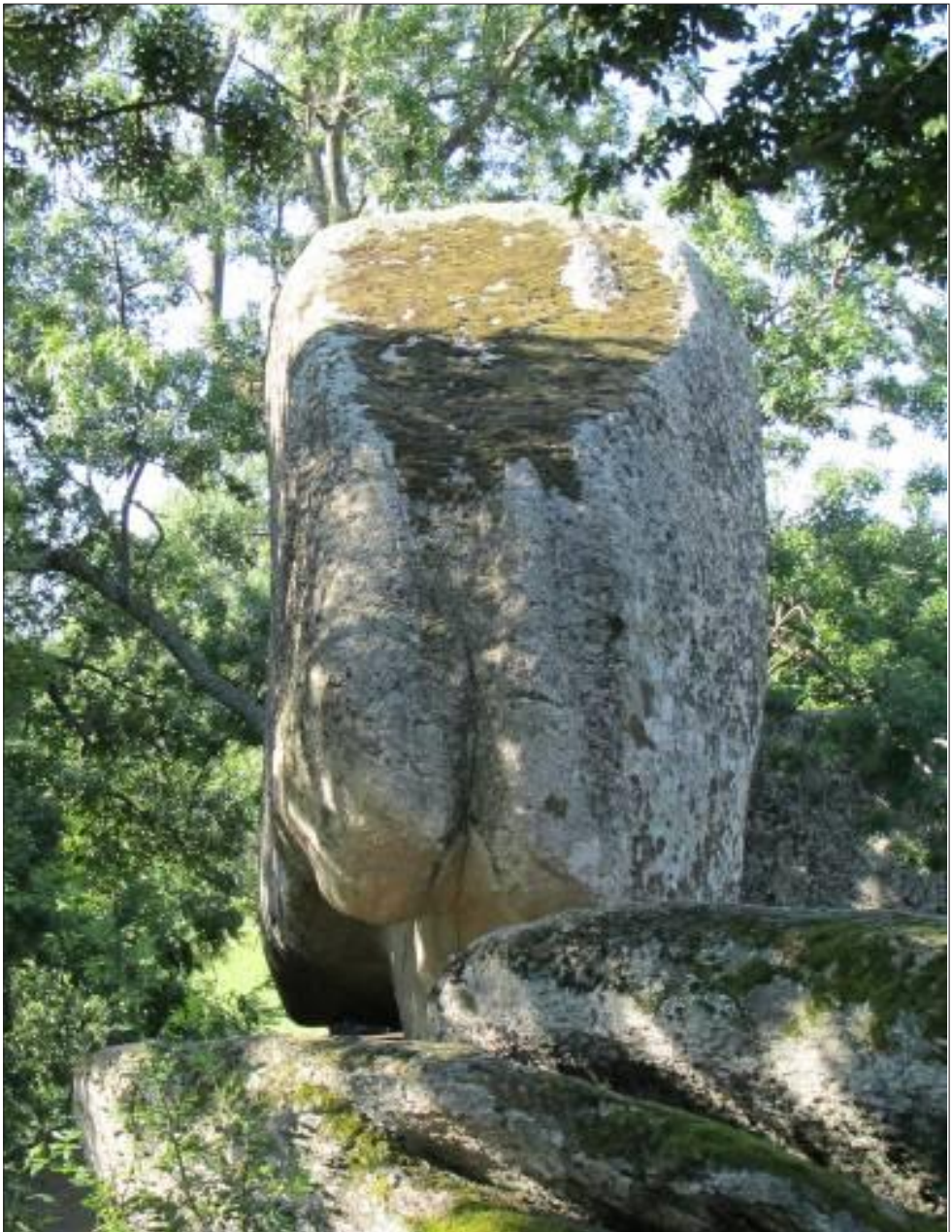

Fig. 17. Apostle Tash, viewed from West

In our opinion, the cavities and the holes in the stone platform are results of human activity in the natural complex of Begliktash.

Outside the complex, formed by elements 1 – 15 in North-East direction towards the sea (Fig. 2), are situated other interesting formations.



Fig. 18. The Holy Cave viewed from the South



Fig. 19. The cut-up megalith 13, viewed from West

The largest of them is a system of vertical rocks with crevices between them measuring from tenths of centimeters to 1 m (Fig.23). The rocks are more that 8 m high and their diameter is up to 12 m. They are known as „The Labyrinth”. The vertical crevices were formed naturally as a result of precipitation and other atmospheric factors.

Next to the Labyrinth there is another rock complex (Fig.24).



Fig. 20. The cut-up megalith 13, viewed from South



Fig. 21. The second „Step of God” on the low rounded monoliths in the southern part of the platform

Further in North-East direction is a stone platform (Fig. 2), in the centre of which there is a stone, which is thought to be a smaller copy of Apostle Tash (Fig. 25). It is called The Small Sanctuary.



Fig. 22. The stone platform on which results of human interference are visible



Fig. 23. The Labyrinth is a natural phenomenon

Along the road in North-East direction one can reach the remains of a stone construction, revealed in recent excavation works, which was called The Priest's home (Fig. 26).

Further along the path which leads to the sea there are stones sticking out of the ground, which have to be dug out and studied.



Fig. 24. Rock complex



Fig. 25. The Small Sanctuary



Fig. 26. The stone construction remains

In the opposite direction, at a distance of about 1 km west of the complex Begliktash, there is an excavation site where in 2014 were found several dolmens and some other archeological objects, which means that the area had been populated in the past.

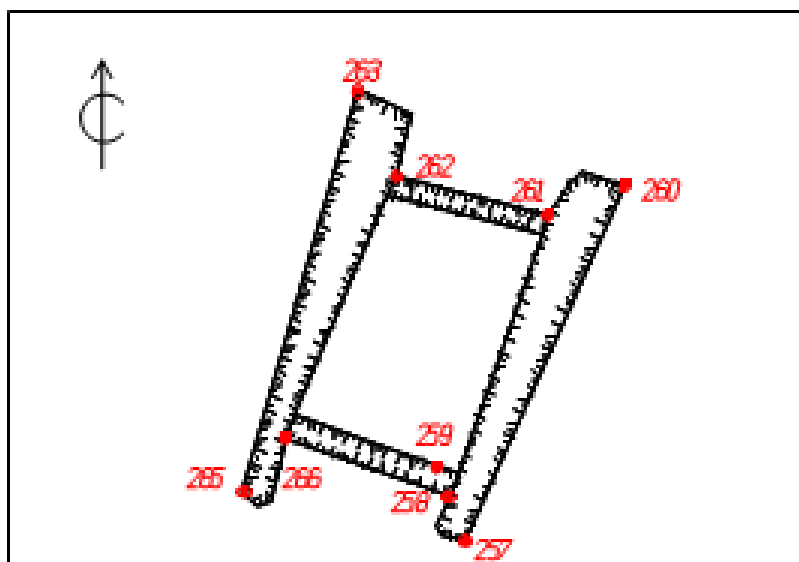

Fig. 27. Geodetic scheme of Zmeyova Dupka dolmen



Fig. 28. Zmeyova Dupka dolmen

Precisely at the spot where the country road leading to Begliktash crosses the highway is located the dolmen called Zmeyova Dupka or The Dragon's Den (its altitude is 187 m). It is the simple rectangular formation which is 3 m long and 1.5 m wide (Fig.27). The dolmen is dug into the ground and its side walls vary in their thickness from 15 cm to 30 cm. On the back wall there is an arch-like opening at the bottom measuring 50 cm. The covering slab which is about 40 cm thick is broken and propped on one of the walls (Fig.28). The long axis of the dolmen makes a 16° angle with the North-East line. To the South of the dolmen there is a staircase-like stone with a length of 2 m and a transverse dimension of about 50 cm.

Astronomical analysis of the complex

Bearing in mind the natural origin of Begliktash complex, one shouldn't expect a purposeful orientation of its elements towards the main directions of the horizon or towards the sunrise or sunset points at particular days of the year, which would have made it possible to use the site for calendar purposes. However, it turned out that some of the megaliths elements could actually serve these purposes. Thus, for example, the long axis of the Matrimonial Bed is aligned in East-West direction, the Throne faces South, the niche of Apostle Tash points towards East; the long axis of the Holy Cave is oriented in North - South direction. This of course might simply be a natural phenomenon. But it is also possible that the natural orientation of the complex elements was used for measuring the time within a day, as well as for calendar purposes.

It seems tempting to assume that the axes of the complex's elliptic shape, at whose periphery stand the main megaliths, are oriented towards East-West and North-South.

Our study of Zmeyova Dupka dolmen confirms the conclusion of Dermendzhiev (2007) that the dolmens in Bulgaria are not aligned with the main directions of the horizon as well as the directions where the Sun sets and rises on particular days of the year which bear a calendar significance.

Conclusion

The megaliths which were registered and measured in Begliktash area weigh up to hundreds of tons, which excludes the possibility of them being transported to the site from another location. That is why it is more logical to assume that Begliktash is a natural phenomenon. However, the anomalies detected in the radioactivity and the magnetic field in the area can serve as an explanation why in pre-historic time the place had been used for performing rituals. This explains why on these colossal stones there are only gutters, cavities and holes carved. In our opinion, these, as well as the throne and some other carvings are the only indisputable signs of human treatment in the otherwise natural complex of Begliktash.

The accidental coincidence in the orientation of some megalith elements with the main directions of the horizon makes us conclude that the complex was used for measuring the time within a day, as well as for calendar purposes.

The fact that the area abounds in dolmens is a clear indication that it was inhabited in pre-historic times.

Acknowledgements. The study of the megaliths is partially funded by project RD-08-285/2014 of Shumen University.

REFERENCES

- Dermendzhiev, N.V. (2007). *Methodology of archaeoastronomical research: analysis of objects and artifacts from the territory of Bulgaria – PhD thesis*. Sofia: Archeological Institute with Museum [Дерменджиев, Н.В. (2007). *Методология на археоастрономическите изследвания: анализ на обекти и находки от територията на България – дисертация*. София: Археологически институт с музей].
- Drazheva, C., Nedev, D. & Panayotova, K. (2004). Trakijsko svetilishte v m. Begliktash na teritoriata na lovno stopanstvo Arkutino, obshtina Primorsko (pp. 154 – 155). In: *Archaeological discoveries and excavations in 2003*. Sofia: AIM [Дражева, Ц., Недев, Д. & Панайотова К. (2004). Тракийско светилище в м. Беглик таш на територията на ловно стопанство Аркутино, община Приморско (с. 154 – 155). В *Археологически открития и разкопки през 2003 г.* София: АИМ.

✉ **Prof. D. Kyurkchieva, DSc (corresponding author)**

Bishop Konstantin Preslavski University of Shumen
115, Universitetska St.
9712 Shumen, Bulgaria
E-mail: kyurk@shu-bg.net